

Date: \_\_\_\_\_ Type: \_\_\_\_\_

Firm Name: \_\_\_\_\_

Project: \_\_\_\_\_



# The P·2

## 43° Beam Angle

Compact LED wash light with maximum output

The P-2 might not look like much, but don't be fooled by its small size. This compact and light fixture packs a large array of features that will suit any need. Based on the groundbreaking P-5 technology, the IP65-rated P-2 comes in a very small and robust chassis weighing only 6.1 kilos/13.4 lbs.

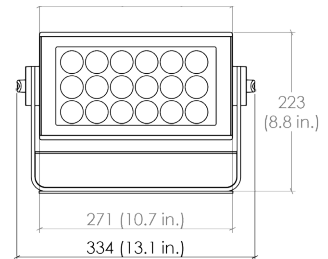

- The fixture features 18 lenses which are divided into 3 individually controllable segments with RGBW colors.

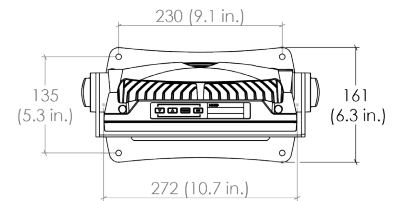

- Due to the high level of variation possibilities, implementing the P-2 in your light design generates wide-ranging colour and effect combinations.
- Containing 18 high power 10W RGBW LEDs, P-2 has a staggering light output of 10,100 lumen – 1,656 lumen per kilo - and an efficacy of 51 lm/W.
- With an unprecedented small physical footprint for this type of product, the extremely compact unit ensures easy and quick setup.
- The P-2 offers a variation of beam angles with 15°, 21° and 43° interchangeable lenses.

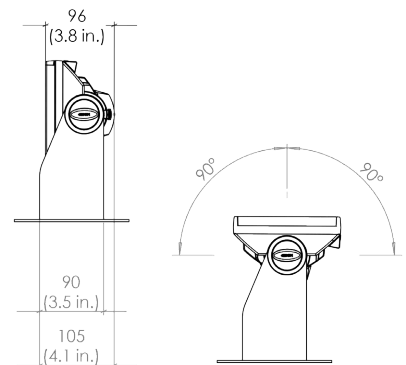

For additional detailed product information, go to <http://sgmlight.com/products/p-2/c-23/p-224>

# Specifications

Due to continuous improvements and innovations, specifications may change without notice.

<b>Optics</b>	Light source LEDs expected lifetime Interchangeable lens option	18 x High power 10W RGBW LEDs 50,000 hours* 15°, 21° & 43°
<b>Photometric</b>	Light output Optical efficacy	10,100 lumen (43° lens)** 51 lm/W
<b>Features</b>	Pan/Tilt LED Panel	0° / 180° 3 individual controllable segments
<b>Electrical</b>	AC Power nominal AC Power max rating Maximum power consumption Typical power consumption Power factor	100 - 277V 50/60Hz 90 - 305V 50/60Hz 275 W (all LEDs on) 200 W (all LEDs on) 0.98 PF (230 V)
<b>Programming and Control</b>	Protocol Setting and addressing DMX channels	USITT DMX512 A RDM Stand alone mode OLED graphical display / 4 buttons Software upgradable via Uploader cable (P/N:83062011) 3, 6, 9, 12, 15 or 22
<b>Physical</b>	Dimensions (L x H x W) Weight Material Lens IP class	334 x 223 x 105 mm (13,2 x 8,8 x 4.1 in) 6.1 kg (13.4 lbs.) Aluminium PE and tempered glass front IP65
<b>Installation</b>	Orientation Rigging possibilities Safety features	Any Floor stand (included) or hanging (Omega Clamp included) Bottom mount for Safety wire
<b>Thermal</b>	Temperature range, Operating Humidity (max.) Cooling	-10° to +40°C (-14° to +104°F) 98% Active, forced air, temperature-regulated, low noise
<b>Connections</b>	DMX data in/out	IP65 Neutrik HD locking XLR 5-pin cable 0.5m, for DMX in and out Power cable 1m with bare ends
<b>Conforms to</b>	2006/95/EC: Low Voltage Directive 2004/108/EC: EMC Directive RoHS2 Directive	EN 60598-1, EN 60598-2-17, EN 62471 EN 55103-1, EN 55103-2, EN 61000-3-2, EN 61000-3-3 2011/65/EU
<b>Included Items</b>	Included Items	Floor Stand (incl. screws) 1 pcs Omega bracket User manual Neopren pouch
<b>Fixtures and Accessories</b>	Fixtures Cables Lens/s Bracket Holders Barndoors Frames	Order no: 80030528 - P-2 Wash Light (43°) Order no: 83062011 - SGM USB uploader cable Order no: 83061134 - P-2, Lens kit (43°) Order no: 83061133 - P-2, Lens kit (21°) Order no: 83061132 - P-2, Lens kit (15°) Order no: 83060602 - Omega bracket Order no: 83061127 - Accessory Holder P-2 series Order no: 83061129 - Barndoor 4-way, P-2/Q-2 series Order no: 83061130 - Barndoor 8-way, P-2/Q-2 series Order no: 83061131 - Color frame, P-2/Q-2 series

IP65 RoHS CE 

\* Figure provided by manufacturer and obtained under manufacturer's test conditions

\*\* Goniometer scan / ocean optics / Viso Light Studio



# Photometrics

43°

All LEDs on

Lux Diagram in m/lux

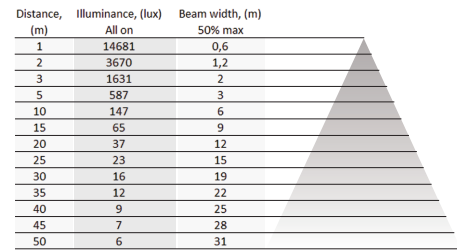

43°

All LEDs on

Lux Diagram in ft/ftc

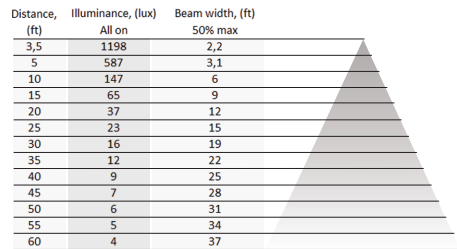

43°

All LEDs on

Polar Candela Distribution

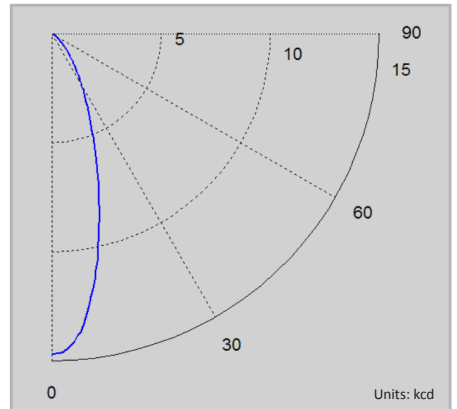

43°

All LEDs on

Beam Profile

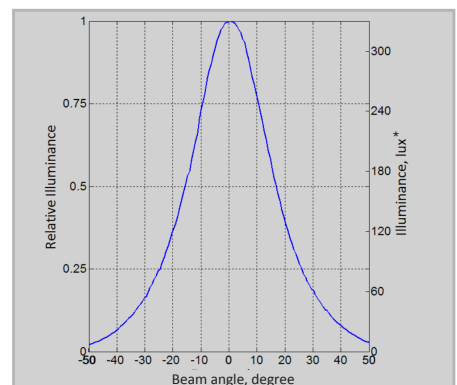

\* Illuminance is measured at a distance of 6.7m.  
For additional information refer to Lux diagram.