

# DP-415R

user manual

©2018 ADJ PRODUCTS LLC all rights reserved. Information, specifications, diagrams, images, and instructions herein are subject to change without notice. ADJ logo and identifying product names and numbers herein are trademarks of ADJ PRODUCTS LLC. Copyright protection claimed includes all forms and matters of copyrightable materials and information now allowed by statutory or judicial law or hereinafter granted. Product names used in this document may be trademarks or registered trademarks of their respective companies and are hereby acknowledged. All non-ADJ brands and product names are trademarks or registered trademarks of their respective companies.

ADJ PRODUCTS LLC and all affiliated companies hereby disclaim any and all liabilities for property, equipment, building, and electrical damages, injuries to any persons, and direct or indirect economic loss associated with the use or reliance of any information contained within this document, and/or as a result of the improper, unsafe, insufficient and negligent assembly, installation, rigging, and operation of this product.

### ADJ PRODUCTS LLC World Headquarters

6122 S. Eastern Ave. | Los Angeles, CA 90040 USA

Tel: 800-322-6337 | Fax: 323-582-2941 | [www.adj.com](http://www.adj.com) | [support@americandj.com](mailto:support@americandj.com)

## DOCUMENT VERSION

Please check [www.adj.com](http://www.adj.com) for the latest revision/update of this guide.

Date	Document Version	Notes
04/20/18	1	Initial version.

# CONTENTS

General Information	4
Limited Warranty	6
Safety Instructions and Guidelines	7
Installation	9
Overview	10
DMX Setup	11
Receive (DMX Control) Mode	12
Chase (Program) Mode	15
Frequently Asked Questions	17
Fuse Replacement	17
Cleaning and Maintenance	18
Technical Specifications	19
Optional Accessories	19

# GENERAL INFORMATION

## INTRODUCTION

The **ADJ® DP-415R™** is a 4-channel Dimmer/Switch Pack which can be controlled via a standard DMX controller or can be used as a stand-alone 4-channel Chase Pack with 16 internal chase programs. Features include zero-crossing circuitry which protects against inductive loads and is compatible and safe for use with most lighting fixtures, two 3-prong Edison socket inputs per channel for a total of eight, 3pin XLR input and output DMX connections, and supports a maximum output load of 15A / 1,800W total. This updated design of the popular DP-415 has replaced confusing dip switches with an easy to use 4-button LED menu control display and now includes RDM (Remote Device Management) protocol support.

## UNPACKING

Every device has been thoroughly tested and has been shipped in perfect operating condition. Carefully check the shipping carton for damage that may have occurred during shipping. If the carton appears to be damaged, carefully inspect your unit for damage and be sure all accessories necessary to operate the unit have arrived intact. In the event damage has been found or parts are missing, please contact our customer support team for further instructions. Please do not return this unit to your dealer without first contacting customer support at the number listed below. Please do not discard the shipping carton in the trash. Please recycle whenever possible.

## CUSTOMER SUPPORT

ADJ® provides a customer support line, to provide set up help and to answer any question should you encounter problems during your set up or initial operation. You may also visit us on the web at [www.adj.com](http://www.adj.com) for any comments or suggestions. For service related issue please contact ADJ.

**ADJ SERVICE USA - Monday - Friday 8:00am to 4:30pm PST**

**Voice: 800-322-6337**

**Fax: 323-532-2941**

E-mail: [support@americandj.com](mailto:support@americandj.com)

## **WARRANTY REGISTRATION**

Please complete and mail in the enclosed warranty card to validate your purchase. All returned service items whether under warranty or not, must be freight pre-paid and accompany a return authorization (R.A.) number. The R.A. number must be clearly written on the outside of the return package. A brief description of the problem as well as the R.A. number must also be written down on a piece of paper and included in the shipping container. If the unit is under warranty, you must provide a copy of your proof of purchase invoice. Items returned without a R.A. number clearly marked on the outside of the package will be refused and returned at customer's expense. You may obtain a R.A. number by contacting customer support.

## **IMPORTANT NOTICE!**

**THERE ARE NO USER SERVICEABLE PARTS INSIDE THIS DEVICE. DO NOT ATTEMPT ANY REPAIRS YOURSELF; DOING SO WILL VOID THE WARRANTY. DAMAGES RESULTING FROM MODIFICATIONS TO THIS DEVICE AND/OR THE DISREGARD OF SAFETY AND OPERATION INSTRUCTIONS IN THIS USER MANUAL VOIDS THE MANUFACTURES WARRANTY AND ARE NOT SUBJECT TO ANY WARRANTY CLAIMS AND/OR REPAIRS.**

# LIMITED WARRANTY

A. ADJ Products, LLC hereby warrants, to the original purchaser, ADJ Products, LLC products to be free of manufacturing defects in material and workmanship for a prescribed period from the date of purchase (see specific warranty periods below). This warranty shall be valid only if the product is purchased within the United States of America, including possessions and territories. It is the owner's responsibility to establish the date and place of purchase by acceptable evidence, at the time service is sought.

B. For warranty service you must obtain a Return Authorization number (RA#) before sending back the product—please contact ADJ Products, LLC Service Department at 800-322-6337. Send the product only to the ADJ Products, LLC factory. All shipping charges must be pre-paid. If the requested repairs or service (including parts replacement) are within the terms of this warranty, ADJ Products, LLC will pay return shipping charges only to a designated point within the United States. If the entire instrument is sent, it must be shipped in its original package. No accessories should be shipped with the product. If any accessories are shipped with the product, ADJ Products, LLC shall have no liability whatsoever for loss of or damage to any such accessories, or for the safe return thereof.

C. This warranty is void if the serial number has been altered or removed; if the product is modified in any manner which ADJ Products, LLC concludes, after inspection, affects the reliability of the product; if the product has been repaired or serviced by anyone other than the ADJ Products, LLC factory unless prior written authorization was issued to purchaser by ADJ Products, LLC; if the product is damaged because not properly maintained as set forth in the instruction manual.

D. This is not a service contract, and this warranty does not include maintenance, cleaning or periodic check up. During the period specified above, ADJ Products, LLC will replace defective parts at its expense with new or refurbished parts, and will absorb all expenses for warranty service and repair labor by reason of defects in material or workmanship. The sole responsibility of ADJ Products, LLC under this warranty shall be limited to the repair of the product, or replacement thereof, including parts, at the sole discretion of ADJ Products, LLC. All products covered by this warranty were manufactured after August 15, 2012, and bear identifying marks to that effect.

E. ADJ Products, LLC reserves the right to make changes in design and/or improvements upon its products without any obligation to include these changes in any products theretofore manufactured. No warranty, whether expressed or implied, is given or made with respect to any accessory supplied with products described above. Except to the extent prohibited by applicable law, all implied warranties made by ADJ Products, LLC in connection with this product, including warranties of merchantability or fitness, are limited in duration to the warranty period set forth above. And no warranties, whether expressed or implied, including warranties of merchantability or fitness, shall apply to this product after said period has expired. The consumer's and/or Dealer's sole remedy shall be such repair or replacement as is expressly provided above; and under no circumstances shall ADJ Products, LLC be liable for any loss or damage, direct or consequential, arising out of the use of, or inability to use, this product. This warranty is the only written warranty applicable to ADJ Products, LLC Products and supersedes all prior warranties and written descriptions of warranty terms and conditions heretofore published.

## LIMITED WARRANTY PERIODS

**Non-LED Lighting Products = 1-Year (365 Days)** (Including Special Effect Lighting, Intelligent Lighting, UV lighting, Strobes, Fog Machines, Bubble Machines, Mirror Balls, Par Cans, Trussing, Lighting Stands, Power/Data Distribution, etc. excluding LED and lamps)

**Laser Products = 1-Year (365 Days)** (excluding laser diodes which have a 6-Month Limited Warranty)

**LED Products = 2-Year (730 Days)** (excluding batteries which have a 180 Day Limited Warranty)

**NOTE: 2-Year (730 Days) Limited Warranty ONLY applies to product purchased within the United States.**

**StarTec Series = 1-Year (365 Days)** (excluding batteries which have a 180 Day Limited Warranty)

**ADJ DMX Controllers = 2 Year (730 Days)**

**American Audio Products = 1 Year (365 Days)**

# SAFETY INSTRUCTIONS AND GUIDELINES



This device is designed for indoor venues, on stage, in nightclubs, theatres, etc. Use of this device outdoors and/or wet environments voids all manufacturers warranties. For proper operation, follow the guidelines described in this manual. Only qualified and certified personnel should perform installation of this device. Any modifications to any part of this device will void the original manufactures warranty and increase the risk of damage and/or personal injury. To guarantee a smooth operation, it is important to follow the guidelines in this manual. The manufacturer of this device will not accept responsibility for damages resulting from the misuse and/or disregard of the information printed in this manual.



This device falls under **PROTECTION CLASS 1**. It's essential this device be grounded properly. Only qualified personnel should perform all electrical connections.



**INDOOR/DRY LOCATION USE ONLY!**

**DO NOT EXPOSE DEVICE TO RAIN OR MOISTURE!**



**RISK OF ELECTRIC SHOCK!**

**DO NOT PLUG INTO A DIMMER PACK!**



**DEVICE MUST BE CONNECTED TO AN APPROPRIATE POWER SOURCE  
IN ORDER TO POWER ANY OF THE AC OUTLETS!**

# SAFETY INSTRUCTIONS AND GUIDELINES

- **DO NOT** position device close to any **FLAMMABLE MATERIALS** while operating.
- **DO NOT** attempt installation and/or operation without knowledge how to do so.
- **DO NOT** permit operation by persons who are not qualified to operate this type of device.
- **DO NOT** shake device, avoid brute force when installing and/or operating.
- **DO NOT** operate fixture if the power cord has become frayed, crimped, damaged and/or if any of the power cord connectors are damaged and do not insert into the fixture securely with ease. **NEVER** force a power cord connector into the fixture. If the power cord or any of its connectors are damaged, replace it immediately with a new one of similar power rating.
- **DO NOT** remove or break-off the ground plug from the power cord.
- **DO NOT** remove disassemble device, there are NO user serviceable parts inside.
- **ALWAYS** disconnect device from main power source before performing any cleaning.
- **ALWAYS** be sure to install this device in an area that will allow proper ventilation. Allow approximately 6 inches (15cm) between this device and a wall or fixture.
- Power cords plugged into the device should be safely routed and secured so they are not likely walked on, pinched, or placed under heavy items.
- Disconnect the main power during long periods of non-use.
- Only use recommended rigging hardware as described in this guide.
- Use the original packaging and materials to transport the device in for service.
- This device should be serviced by qualified service personnel when:
  - A. The power cord or plug has become damaged.
  - B. Objects have fallen on and/or liquid has spilled into the device.
  - C. The device has been exposed to rain and/or moisture.
  - D. The device does not operate normally or exhibits a marked change in performance.



# INSTALLATION

## CLAMP / TRUSS MOUNTING

The pack can be mounted to truss or a lighting stand using an ADJ clamp (not included).

1. Attach clamp securely to the mounting hole on the top of the pack using an **M10-1.5** screw.
2. Make sure the clamp is firmly attached to the pack before mounting to truss or a lighting stand.

**MAKE SURE STRUCTURE CAN SUPPORT THE WEIGHT OF THE DEVICE!**



## MAXIMUM POWER LOAD PER OUTLET AND PER PACK

**Each CHANNEL POWER OUTLET can support a maximum load of 5A / 600W.**

**Each DP-415R PACK can support a maximum total load of 15A / 1800W.**

**NOTE: ALWAYS CHECK THE POWER CONSUMPTION OF EACH DEVICE BEFORE YOU CONNECT IT TO THE PACK. DO NOT EXCEED THE MAXIMUM LOAD CAPACITY OF A CHANNEL OR THE PACK.**

# OVERVIEW

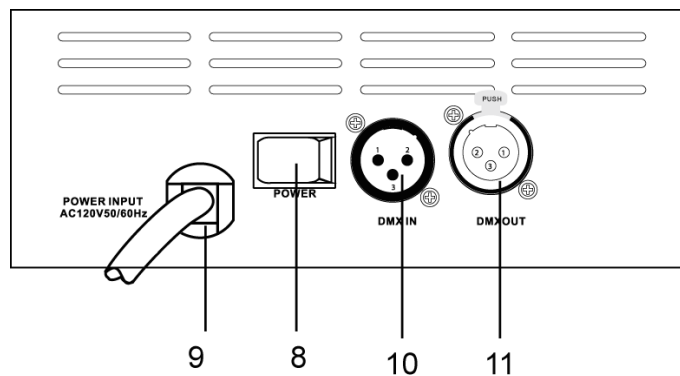
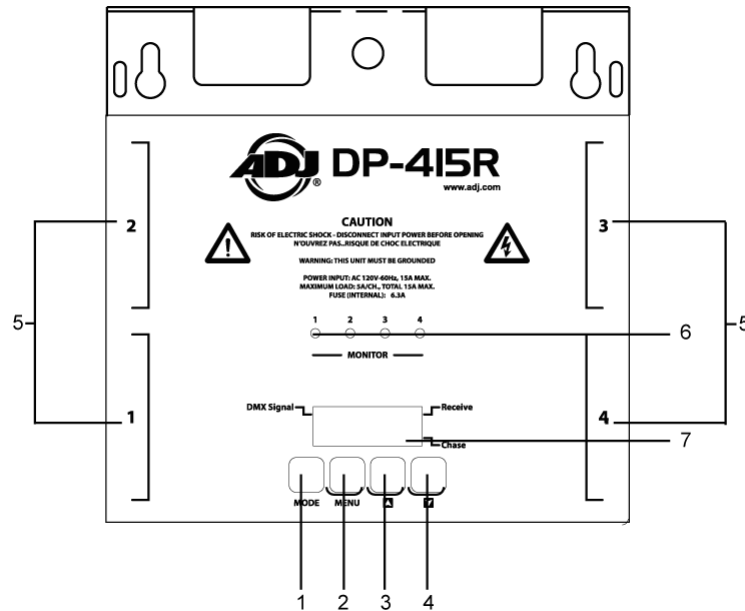

1. **MODE Button** – Changes operation between Receive (DMX Control) and Chase Modes
2. **MENU Button** – Access different functions in Receive (DMX Control) and Chase Modes
3. **UP Button** – Increase menu values in the LED display
4. **DOWN Button** – Decrease menu values in the LED display
5. **POWER OUTPUTS** – 3-prong grounded Edison Outlet Sockets (8 total)
6. **GREEN LED Monitors** – Indicates relevant channel activity
7. **LED Display** - Indicates device mode - Receive (DMX controlled) or Chase
8. **POWER SWITCH** – Main power control to the device
9. **POWER CABLE** – 5 ft (1.5m) Attached power cable to connect to main power source
10. **DMX IN** – 3pin XLR DMX input signal
11. **DMX OUT** – 3pin XLR DMX output signal

# DMX SETUP

## POWER SUPPLY

Before powering ON the device, make sure source voltage matches the required voltage listed on the device. Line voltages may vary depending on the location, so use caution before powering the device.

## DATA CABLE (DMX CABLE) REQUIREMENT

This device requires an approved DMX-512 110 Ohm data cable for signal input and output. We recommend ADJ Accu-Cable DMX cables. If custom DMX cables are being made, make only sure standard 110-120 Ohm shielded cable is used. Cables should be made with a male and female XLR connector on either end of the cable. Also remember DMX cable must be daisy chained and cannot be split.



## IMPORTANT NOTE

DO NOT use the ground lug on the XLR connector! DO NOT connect the cable's shield conductor to the ground lug or allow the shield conductor to come in contact with the XLR's outer casing! Grounding the shield could cause a short circuit and erratic behavior!

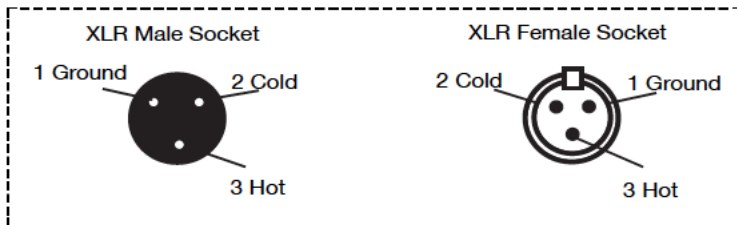
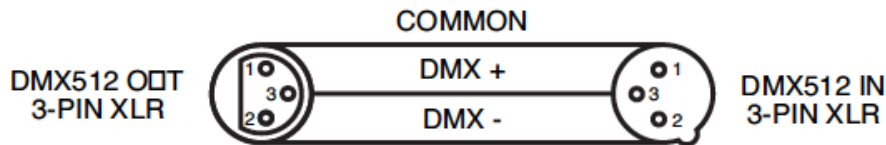

XLR Pin Configuration
Pin 1 = Ground
Pin 2 = Data Compliment (negative)
Pin 3 = Data True (positive)

## IMPORTANT NOTE – LINE TERMINATION

When using long extended runs of DMX cable, a DMX line terminator connected to the last DMX device is needed in order to decrease the possibilities of erratic device behavior. A DMX line terminator is a standard 90 - 120-ohm 1/4-watt resistor connected between pins 2 and 3 of the male XLR connector (DATA + and DATA -). This XLR connector is inserted into the female XLR connector on the last device in the daisy chain to terminate the line.

## RECEIVE (DMX CONTROL) MODE

This mode allows the device to be used as a 1, 2, or 4 channel DMX controlled Switch or Dimmer pack.

In **Switch** mode, selected channel outputs can be switched ON/OFF via DMX.

In **Dimmer** mode, select channel outputs can be gradually dimmed UP or DOWN via DMX.

See the chart on page 14 for DMX ON/OFF values.

1. Connect the pack to an appropriate power source and switch the power to ON.

2. Press the MODE button to select Receive (DMX CONTROL) Mode.

The MODE LED will be illuminated next to the word Receive. (see LED display image below)



3. Set the desired DMX Address (001-512) for the pack by pressing **UP** or **DOWN** buttons.

The DMX Address can also be set from a DMX controller using RDM (Remote Device Management).

4. Set the desired Channel mode by pressing the **MENU** button once, then pressing the **UP** or **DOWN** buttons to select 1, 2, or 4 channel mode. (see LED display images below)

Using **CH:01** mode groups all 4 output channels together.

Using **CH:02** mode groups output channels 1 and 2 together and output channels 3 and 4 together.

Using **CH:04** mode allows individual control of each output channel separately.

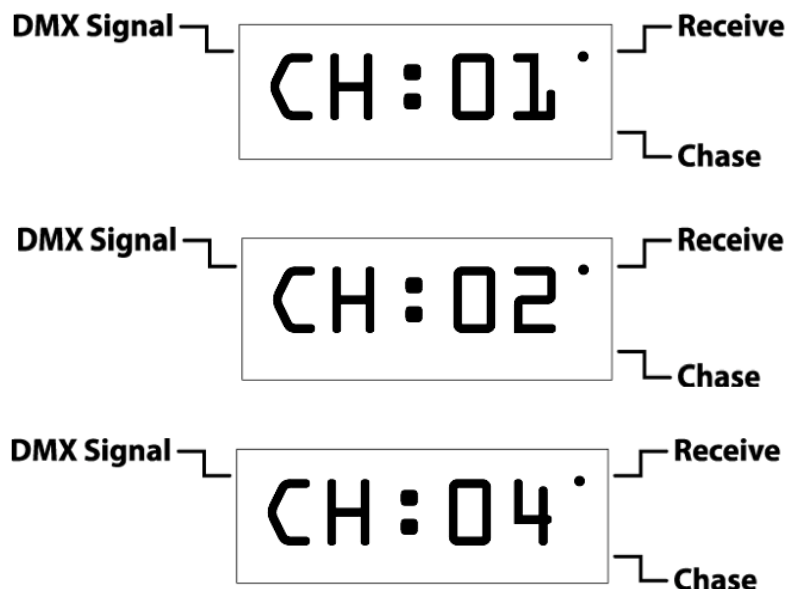

## RECEIVE (DMX CONTROL) MODE

5. Set each Channel to **Switch** or **Dimmer** mode by pressing the **MENU** button to select the desired channel (**C1, C2, C3, C4**) Then press the **UP** or **DOWN** buttons to select **S** for Switch or **d** for Dimmer. (see images below)

LED Display Showing Channel 1 in Switch Mode

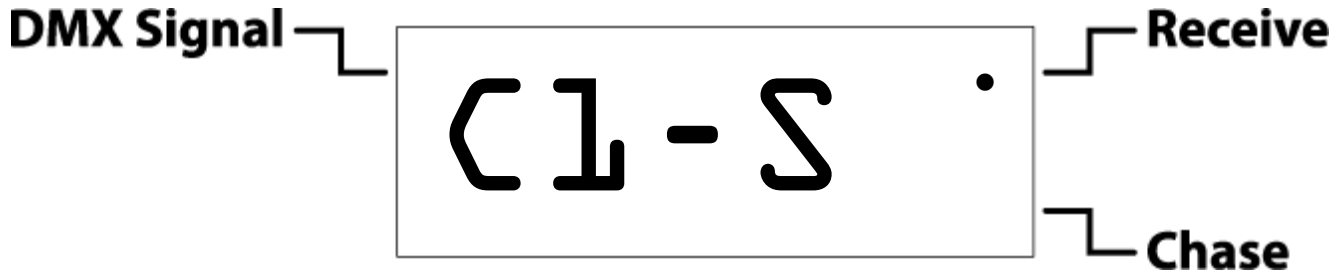

LED Display Showing Channel 1 in Dimmer Mode

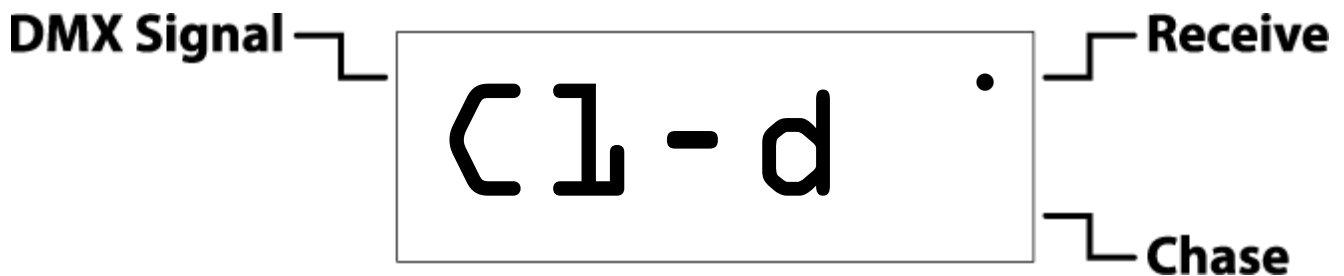

6. Press the **MENU** button until the DMX address shows on the LED display. (see LED image below)



7. Connect a 3pin XLR cable (not included) from the DMX controller to the DMX IN and connect a 3pin XLR cable (not included) from the DMX OUT port on the pack to the next DMX device if used.

8. Connect lighting devices to the any of the 4 sets of channel sockets on the pack.

**\*\*\* DO NOT EXCEED MAX 15A / 1,800W Total per unit | 5A / 600W Total per any channel \*\*\***

9. Pack channels can now be controlled via DMX and each channel will function either as a switch (on/off) or as a dimmer (0-100%) according to the mode they were set to in step 5 above.

# RECEIVE (DMX CONTROL) MODE

<b>ADJ DP-415R</b>				
<b>DMX Channel Values / Functions (4 DMX Channels)</b>				
<b>CHANNEL MODE</b>			<b>VALUE</b>	<b>FUNCTION</b>
<b>CH:01</b>	<b>CH:02</b>	<b>CH:04</b>		
1	1	1		<b>OUTLET 1 - SWITCH MODE</b>
			0-126	OFF
			127-255	ON
				<b>OUTLET 1 - DIMMER MODE</b>
		0-255	Dimmer Intensity 0 to 100%	
		2		<b>OUTLET 2 - SWITCH MODE</b>
			0-126	OFF
			127-255	ON
			<b>OUTLET 2 - DIMMER MODE</b>	
	0-255	Dimmer Intensity 0 to 100%		
	2	3		<b>OUTLET 3 - SWITCH MODE</b>
			0-126	OFF
			127-255	ON
				<b>OUTLET 3 - DIMMER MODE</b>
		0-255	Dimmer Intensity 0 to 100%	
		4		<b>OUTLET 4 - SWITCH MODE</b>
0-126			OFF	
127-255			ON	
	<b>OUTLET 4 - DIMMER MODE</b>			
0-255	Dimmer Intensity 0 to 100%			

## CHASE (PROGRAM) MODE

This mode allows the device to be used as a 4 channel stand-alone Chase pack with 16 internal programs, Switch or Dimmer modes for each channel, and adjustable speed and dimmer settings.

In **Switch** mode, selected channel outputs are switched ON/OFF based on the selected program.

In **Dimmer** mode, the selected channel outputs are dimmed based on the selected program.

1. Connect the pack to an appropriate power source and switch the power to ON.

2. Press the MODE button to select Chase (PROGRAM) Mode.

The MODE LED will be illuminated next to the word Chase. (see LED display image below)

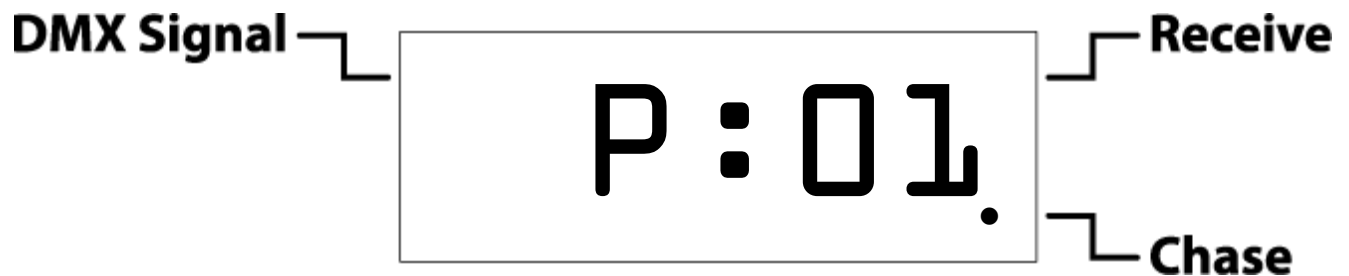

3. Set the desired CHASE Program (1-16) for the pack by pressing **UP** or **DOWN** buttons.

4. Set the desired CHASE Program **SPEED** by pressing the **MENU** button once, then pressing the **UP** or **DOWN** buttons to set the speed from 01 to 99. A value of 99 is the fastest chase speed (about 1/10th of a second), and a value of 01 is the slowest chase speed (one step every 30 sec.).

(see LED display image below)



5. Set the desired CHASE Program **DIMMING** by pressing the **MENU** button once, then pressing the **UP** or **DOWN** buttons to set the dimmer from 000 to 100. A value of 000 is blackout and a value of 100 is the brightest dimmer setting. (see LED display image below)



6. Set each Channel to **Switch** or **Dimmer** mode by pressing the **MENU** button to select the desired channel (**C1, C2, C3, C4**) Then press the **UP** or **DOWN** buttons to select **S** for Switch or **d** for Dimmer. (see images below)

**LED Display Showing Channel 1 in Switch Mode**

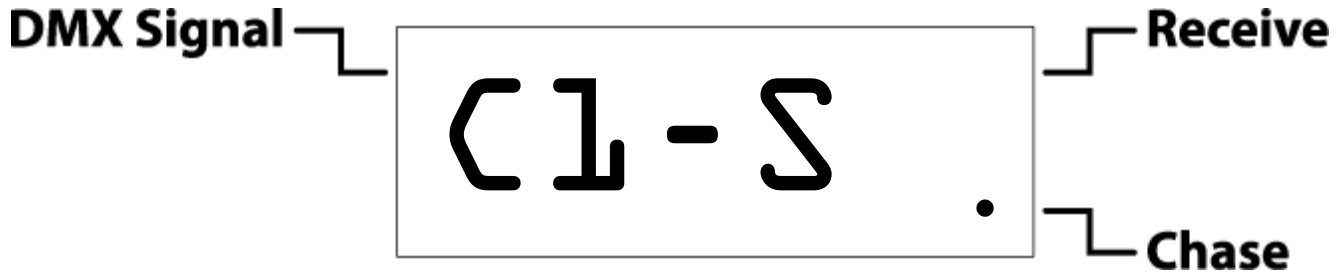

**LED Display Showing Channel 1 in Dimmer Mode**

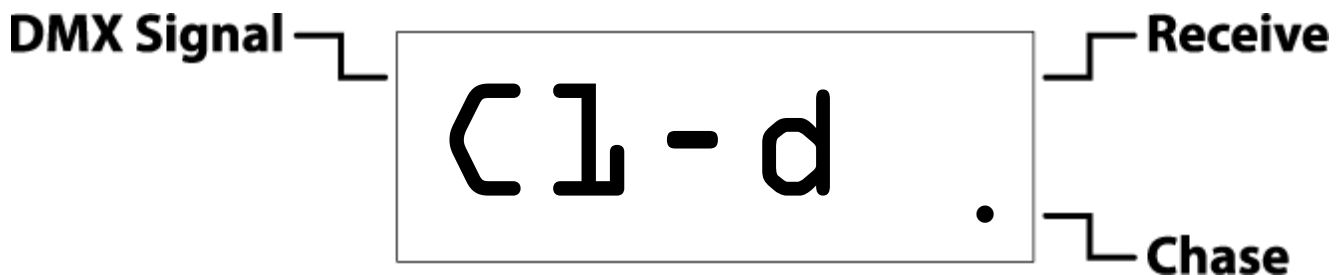

7. Press the **MENU** button until the CHASE Program number shows on the LED display. (see LED image below)

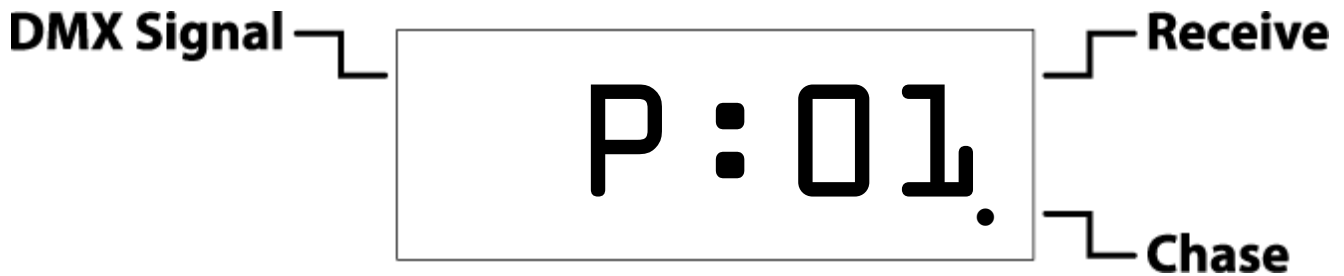

8. Connect lighting devices to the any of the 4 sets of channel sockets on the pack.

**\*\*\* DO NOT EXCEED MAX 15A / 1,800W Total per unit | 5A / 600W Total per any channel \*\*\***

9. Pack channels will now chase controlled via the CHASE program selected and each channel will function either as a switch (on/off) or as a dimmer (0-100%) according to the mode they were set to in step 6 above.



# FREQUENTLY ASKED QUESTIONS

Listed below are a few answers to common questions.

## 1. NO POWER TO THE PACK

Disconnect the power cord and reconnect to ensure there is a proper connection. If the problem still persists, check the venue/building electrical service panel for any circuit breakers that are tripped/off.

## 2. NO CHANNEL OUTPUT

Check the device power cords connected to the pack are properly inserted into the channel outlets and each device power switch (if used) is powered ON. If the problem still persists, check the internal fuses. (see Fuse Replacement instructions below)

## 3. NO DMX CONTROL

Check the 3pin DMX IN/OUT cable connections to the pack are properly attached and the cables are not damaged. If problem still persists, check the DMX Controller is connected and powered On, and it is sending the correct DMX values. (see DMX traits on page 14), Check the correct DMX address is assigned to the pack. (see DMX Address settings on page 12)

## 4. NO OUTPUT IN PROGRAM MODE

Check Dimmer mode for each Channel setting. If Dimmer mode is set to 000 then none of the connected lights will turn on because 000 is blackout. Set the Dimmer mode for each channel to a desired Dimmer setting higher than 000. (see page 15 for Dimmer settings)

# FUSE REPLACEMENT

Disconnect the power cord. Check the corresponding channel fuse or fuses by removing the four phillips head screws on the rear panel to expose the circuit board and fuses. Each channel fuse is marked on the PCB- TH1 = Channel 1, TH2 = Channel 2, TH3 = Channel 3 and Th4 = Channel 4. Check the relevant channel fuse or fuses and replace if required. The DP-415 incorporates four 6.3A 250V normal blow fuses. Replace rear panel and phillips head screws.



# CLEANING AND MAINTENANCE



**C A U T I O N**

**Disconnect power before cleaning or maintenance.**

## CLEANING

Occasional cleaning is recommended to insure proper function and an extended life. The frequency of cleaning depends on the environment in which the pack operates: damp, smoky or particularly dirty environments can cause greater accumulation of dirt on the pack. Clean the external pack surface with a soft cloth to avoid dirt/debris accumulation.

**NEVER use alcohol, solvents, or ammonia-based cleaners.**

## MAINTENANCE

Regular inspections are recommended to insure proper function and extended life.

There are no user serviceable parts inside this fixture, please refer all other service issues to an authorized Elation service technician. Should you need any spare parts, please order genuine parts from your local ADJ dealer.

Please refer to the following points during routine inspections:

- A detailed electric check by an approved electrical engineer every three months, to make sure the circuit contacts are in good condition and prevent overheating.
- Be sure all screws and fasteners are securely tightened at all times. Loose screws may fall out during normal operation resulting in damage or injury as larger parts could fall.
- Check for any deformations on the housing, rigging hardware and rigging points. Deformations in the housing could allow for dust to enter into the pack. Damaged rigging points or unsecured rigging could cause the pack to fall and seriously injure a person(s).
- Electric power supply cables must not show any damage, material fatigue or sediments. Never remove the ground prong from the power cable.

# TECHNICAL SPECIFICATIONS

## CONTROL

DMX-512

RDM (Remote Device Management)

16 Internal Chase Programs

## CONNECTIONS

8 Grounded 3-prong Edison Outlet Sockets

3pin XLR DMX Input

3pin XLR DMX Output

5ft (1.5m) Attached 3-prong AC Power Cord

Power Switch

## SIZE / WEIGHT

Length: 10.2" (260 mm)

Width: 8.2" (209 mm)

Horizontal Height: 3.0" (76 mm)

Weight: 6.0 lbs. (2.72 kg)

## ELECTRICAL / THERMAL

Maximum AC Output Current: 15A / 1,800W Total per unit | 5A / 600W Total per any channel\*

Fuse: 6.3A 240V Normal Blow

Operating Voltage: 120V AC, 60Hz

Spike Protection Mode: Line to Neutral

## APPROVALS

CE

## OPTIONAL ACCESSORIES

ORDER CODE	ITEM
C-CLAMP	MEDIUM DUTY C CLAMP
Z-FUSE/GMA-7A	7A FUSE FOR MULTIPLE UNITS
AC3PDMX3	3' (0.9m) 3pin XLR DMX Cable
	Additional Cable Lengths Available

ADJ Products, LLC  
6122 S. Eastern Ave. Los Angeles, CA 90040 USA  
Tel: 323-582-2650 / Fax: 323-725-6100  
Web: [www.adj.com](http://www.adj.com) / E-mail: [info@americandj.com](mailto:info@americandj.com)

A.D.J. Supply Europe B.V.  
Junostraat 2  
6468 EW Kerkrade  
The Netherlands

Follow Us On:



[facebook.com/americandj](https://facebook.com/americandj)  
[twitter.com/americandj](https://twitter.com/americandj)  
[youtube.com/adjlighting](https://youtube.com/adjlighting)

[support@adjgroup.eu](mailto:support@adjgroup.eu) / [www.adj.eu](http://www.adj.eu)  
Tel: +31 45 546 85 00 / Fax: +31 45 546 85 99